

PUMP



# AIR DRIVEN HYDRAULIC PUMP UNIT

氣動油壓泵浦單元

MODEL **PA** **PC**



PA-1P2V



PA-1P3V



PA-1P1V



PC-1P4V



PA-1P4V



PC-2P4V



PC-2P6V

- Use air to drive hydraulic pump. Once the outlet hydraulic pressure reaches the setting pressure, it will stop driving and won't waste any energy.  
If the outlet pressure is reducing, it will supplement pressure automatically to maintain the pressure continuously.
- The outlet pressure of the pump and the pneumatic pressure of driving are as direct ratio. The outlet pressure will base on the adjustment of pneumatic pressure to change.
- The hydraulic pressure (available hydraulic pressure from 60 ~ 500 kg/cm<sup>2</sup>), flow rate of pump and circuit control system will base on the requirement to be different.
- The circuit control system has the function of check. If there is no pneumatic pressure, the hydraulic pressure will be maintained.
- The best application is for work clamping systems or hydraulic pressure supply system which needs to maintain pressure for a long time but less operate.
- It has the function of inspection pressure and can be interlocked with the machine.

- 利用空氣驅動泵浦，出口油壓達設定壓力立即停止作動不需繼續消耗能源，若出口油壓下降則自動補壓，具持續保持壓力功能。
- 泵浦的出口壓力與驅動的空氣壓力成正比，因此出口壓力也隨著空氣壓力的調節而變化。
- 可依需要搭配不同出力 (60~500kg/cm<sup>2</sup>)、不同流量之泵浦及不同型式之迴路控制系統。
- 迴路控制系統具逆止功能，空氣壓力消失時油壓壓力可保持。
- 最適用於油壓夾治具或作動不頻繁，需較長時間持壓之油壓供給系統。
- 具壓力檢出功能，可與機台連線。



## MODEL SELECTION 型式選定



① Pump model / 泵浦型式  
PA06~16 PC09~22

V Non-leak valve control  
氣控閥控制

⑥ Numbers of pressure switch  
壓力開關之數量

② Pump numbers  
泵浦數1.2

④ "NO" Type numbers of solenoid valve  
電磁閥NO之數量

⑦ Electronic control voltage  
電壓 0:DC24V 1:110V 2:220V

③ Numbers of control circuit  
迴路數: 1,2,3,4,5...

⑤ "NC" Type numbers of solenoid valve  
電磁閥NC之數量

## OUTLINE DIMENSIONS 外型尺寸

PA

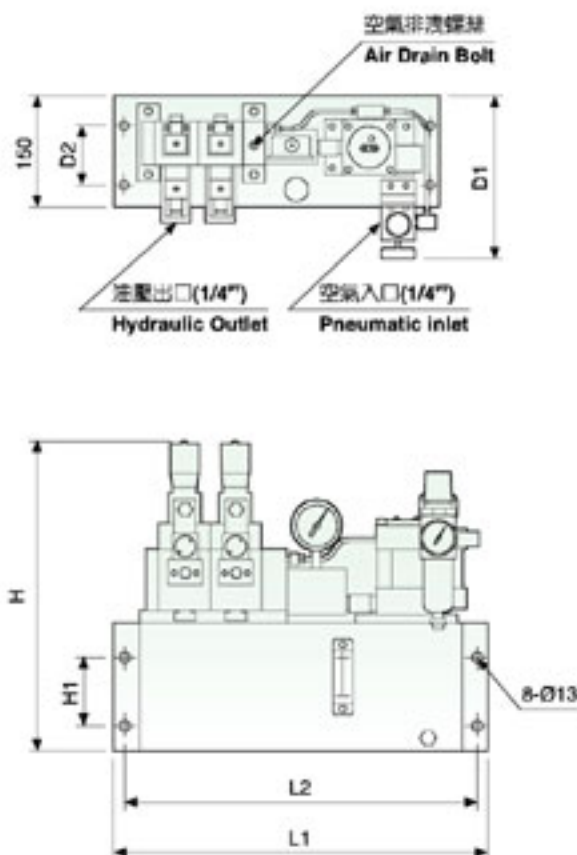

PC

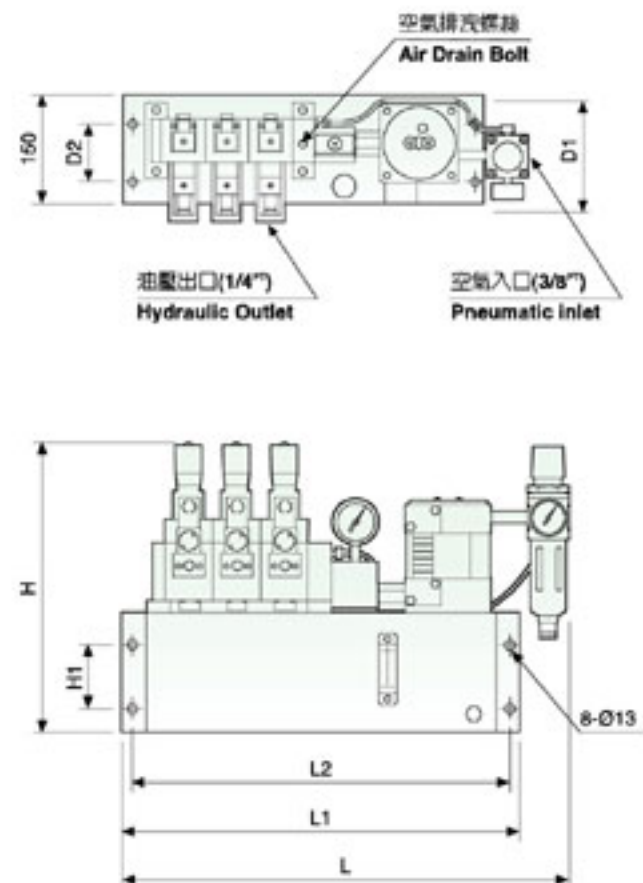

MODEL 型式	L1	L2	H	H1	D1	D2
PA08-1P1V	378	353	355	80	235	80
PA08-1P2V	438	413	355	80	235	80
PA08-1P3V	498	473	355	80	235	80
PA08-1P4V	588	563	360	80	235	80

■ Numbers of pump & Non-leak valve depend on control circuits.  
可依迴路需要增加泵浦及氣控閥

MODEL 型式	L	L1	L2	H	H1	D1	D2
PC12-1P1V	470	378	353	365	80	175	80
PC12-1P2V	530	438	413	365	80	175	80
PC12-1P3V	600	498	473	365	80	175	80
PC12-1P4V	680	588	563	365	80	175	80
PC12-2P4V	960	800	775	420	80	225	80

■ Numbers of pump & Non-leak valve depend on control circuits.  
可依迴路需要增加泵浦及氣控閥

# AIR DRIVEN HYDRAULIC PUMP 氣動油壓泵浦

MODEL **PA** **PC**

**PA**

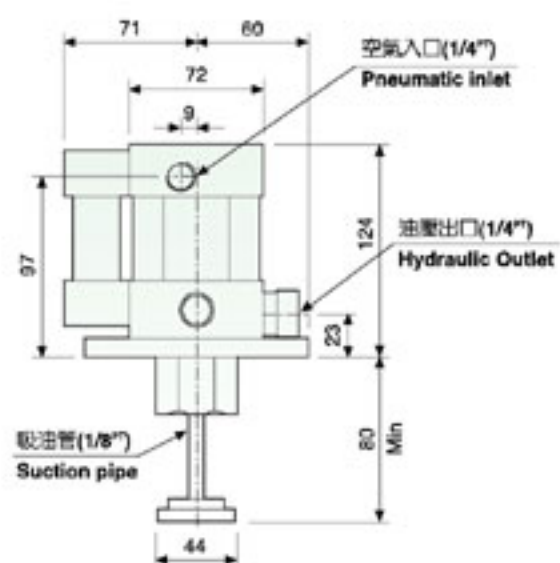
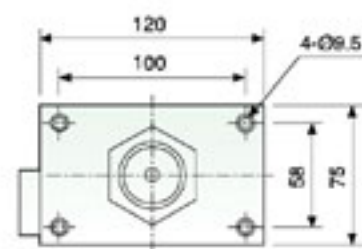

MODEL 型式	PA06	PA07	PA08	PA09	PA10	PA12	PA14	PA16
Hydraulic pressure 油壓出力 <b>kgf/cm<sup>2</sup></b>	420	320	250	200	160	100	90	60
Flow (cc/min) 流量 <b>cc</b>	680	830	1200	1350	1600	2000	2250	2500

■ Air pressure supplied at 5 kgf/cm<sup>2</sup> / 以上使用空氣壓力為5kgf/cm<sup>2</sup>時

**PC**

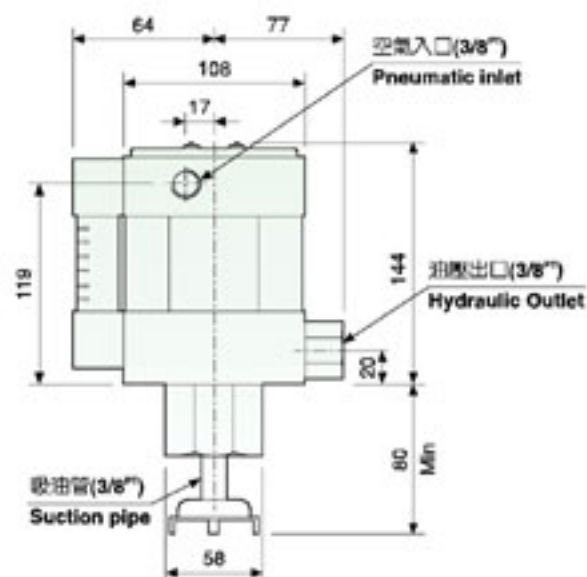
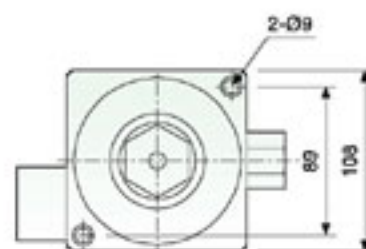

MODEL 型式	PC09	PC10	PC12	PC14	PC16	PC18	PC20	PC22
Hydraulic pressure 油壓出力 <b>kgf/cm<sup>2</sup></b>	500	410	260	200	160	120	100	80
Flow (cc/min) 流量 <b>cc</b>	1150	1400	2000	2500	3800	4750	5010	5300

■ Air pressure supplied at 5 kgf/cm<sup>2</sup> / 以上使用空氣壓力為5kgf/cm<sup>2</sup>時

Description on construction and operation 泵浦構造及作動說明

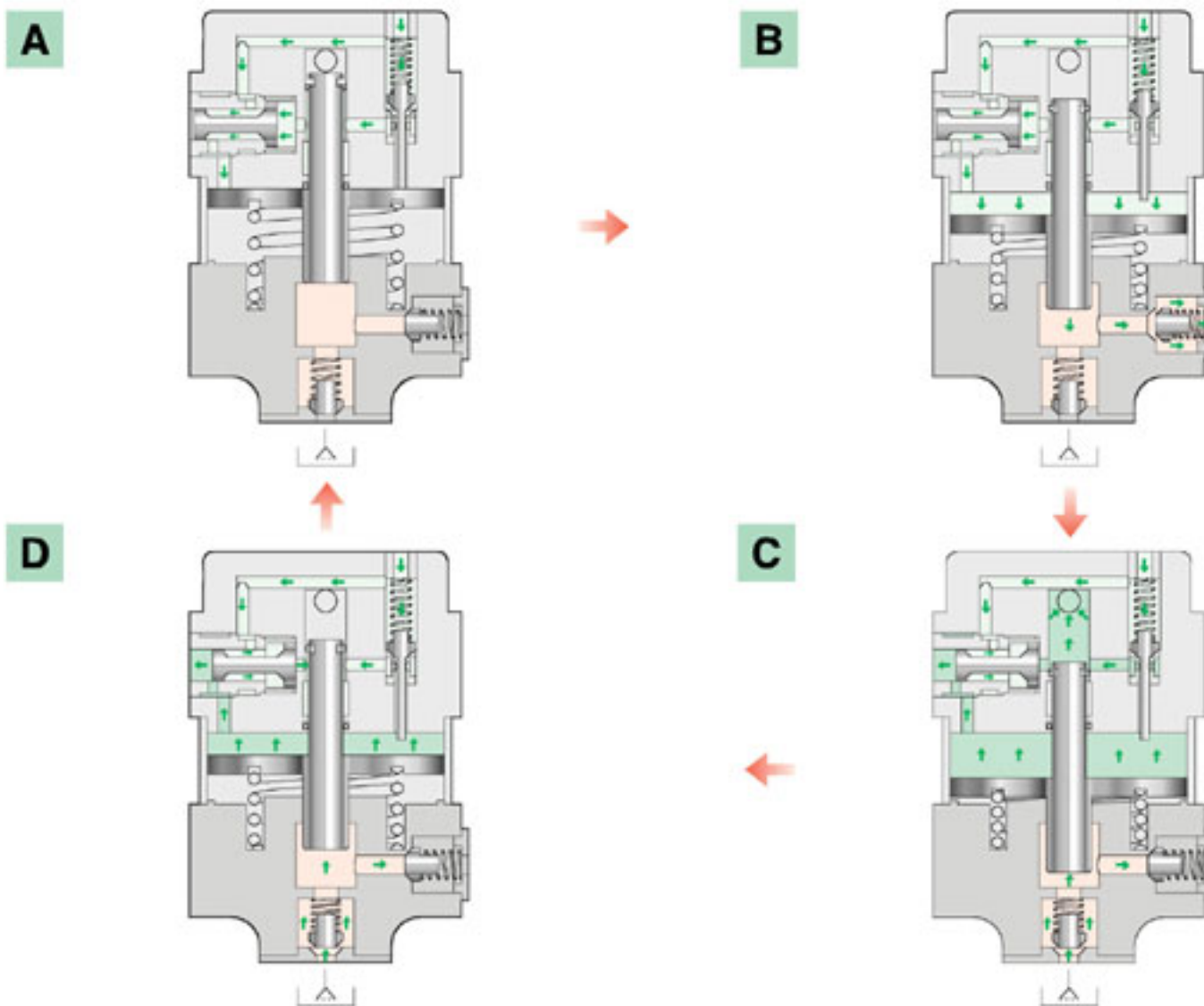

# NON-LEAK VALVE

氣控閥單元



MODEL

**SV04**

**SV10**

## Characteristic 特性

- It won't leak oil inside, and has the function to maintain pressure for a long time.
- Application for:
  - a. Clamp & oil cylinder.
  - b. Hydraulic pressure supply system which requires to maintain pressure for a long time.
- 具有零內漏, 長時間持壓功能.
- 最適用於夾具、油壓缸及長時間續壓供給系統.

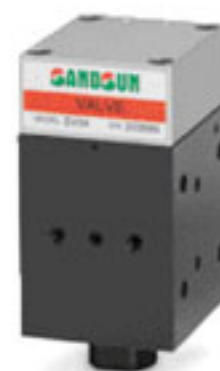

SV04



SV10

MODEL 型式	SV04	SV10
Effective dimension/有效斷面積 mm <sup>2</sup>	25	15



## SLIDE LOCK 滑塊固鎖

### APPLICATION:

High speed press-slide lock  
Single circuit control

適用於：

高速沖床滑塊固鎖  
單一迴路的控制

### MODEL SELECTION 型式選定

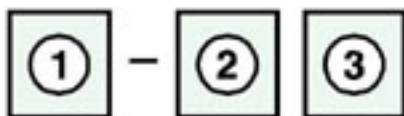

- ① Pump model / Specification  
泵浦型式/規格  
PE06~08  
PF06~08

- ② Assembly code  
配件代號

**P:** Pressure switch  
壓力開關

**R:** Pressure release valve  
洩壓閥

**S:** Pressure regulator valve  
調壓閥

- ③ Electronic control voltage  
電壓 0:DC24V 1:110V 2:220V

MODEL 型式		PE06	PE07	PE08
Hydraulic pressure / 油壓出力	kgf/cm <sup>2</sup>	250	210	160
Flow (cc/min) / 流量	cc	900	1100	1300

MODEL 型式		PF06	PF07	PF08
Hydraulic pressure / 油壓出力	kgf/cm <sup>2</sup>	420	320	250
Flow (cc/min) / 流量	cc	1000	1300	1600

■ Air pressure supplied at 5 kgf/cm<sup>2</sup> / 以上使用空氣壓力為5kgf/cm<sup>2</sup>時

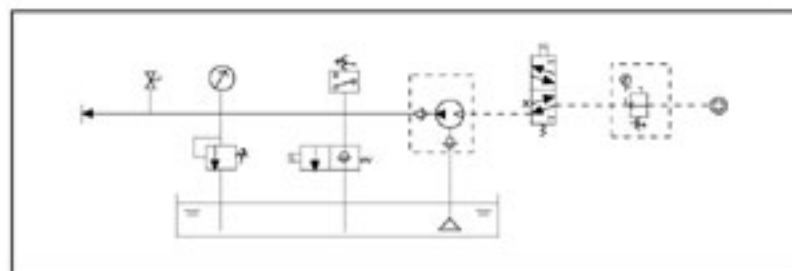

PE-PRS



PF-PRS

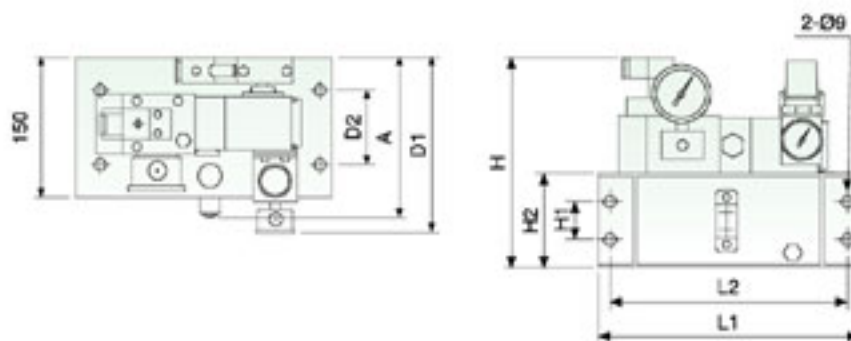

MODEL 型式	L1	L2	H	H1	H2	D1	D2	A
PE	275	250	250	40	100	-	80	170
PF	275	250	300	80	150	210	80	175

**2E**

### APPLICATION:

Hydraulic pressure supply for feeder  
適用於：送料架之油壓供給(1P2E)

### MODEL SELECTION 型式選定

PA10 - **2E** **①**

- PA10 Pump specification  
泵浦規格

- 2E** Control circuit board  
迴路板

- ①** Electronic control voltage  
電壓 0:DC24V 1:110V 2:220V

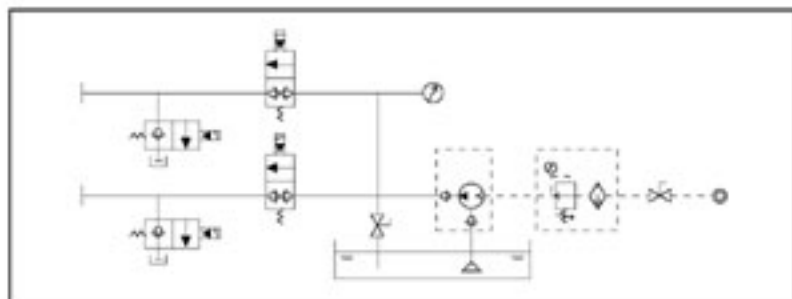

PA-1P2E

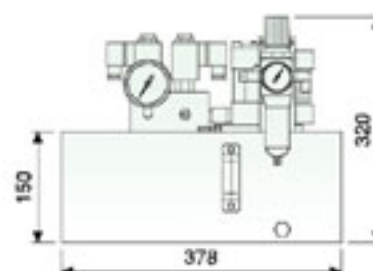
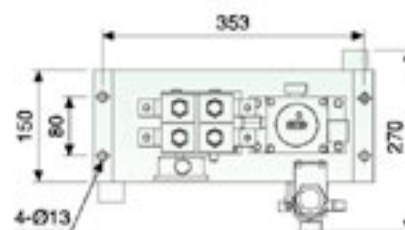

## STICK RELEASE 卡模解脫

### APPLICATION:

Press and hydraulic press -stick release  
適用於：沖床油壓機之卡模解脫

### MODEL SELECTION 型式選定



① Pump model / Specification  
泵浦型式/規格

PA06~16  
PC09~22

② B: Manual operation  
手動操作控制

E: Inserting solenoid valve  
插入式電磁閥控制

③ Assembly code  
配件代號

P: Pressure switch  
壓力開關

R: Pressure release valve  
洩壓閥

S: Pressure regulator valve  
調壓閥

④ Electronic control voltage  
電壓 0:DC24V 1:110V 2:220V



PA-1P1B



PA-1P1E

**B**

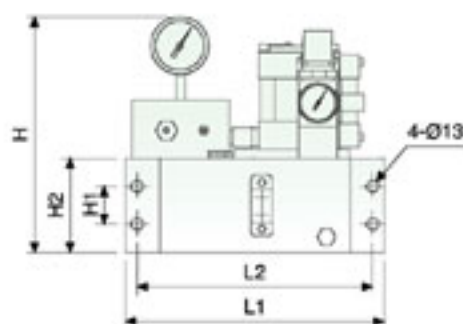
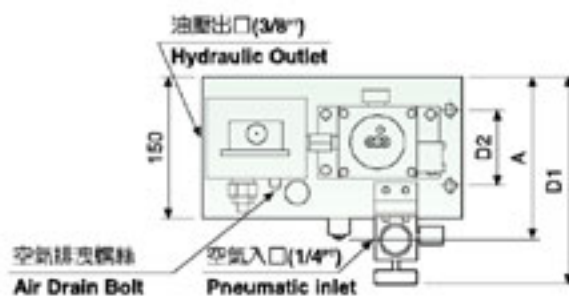

MODEL 型式	L1	L2	H	H1	H2	D1	D2	A
B系列	275	250	280	40	100	220	80	170
	275	250	330	80	150	220	80	175

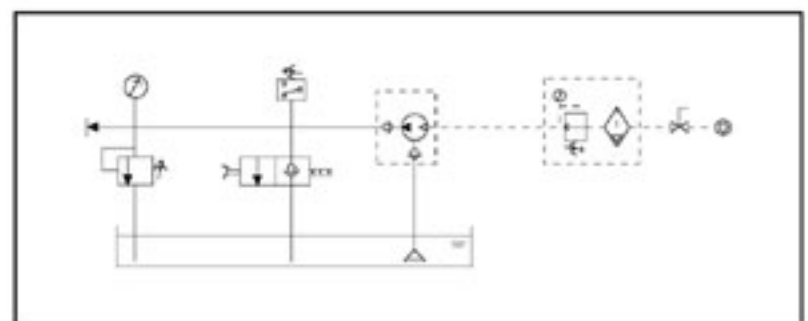

**E**

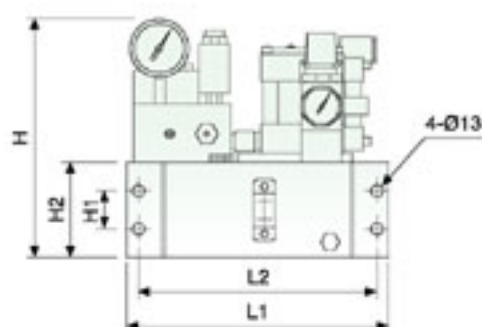
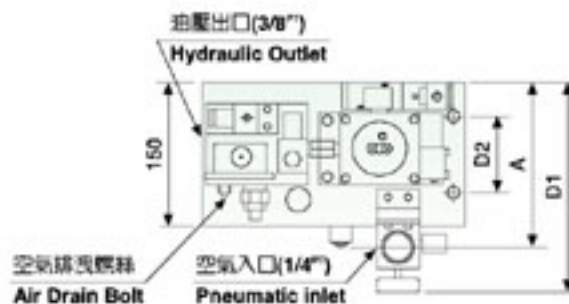

MODEL 型式	L1	L2	H	H1	H2	D1	D2	A
E系列	275	250	235	40	100	220	80	170
	275	250	285	80	150	220	80	175

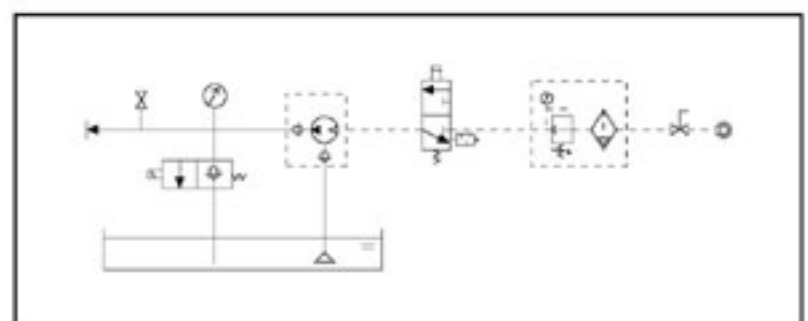

ISO 9001 

**MANAGING PHILOSOPHY:** MODERATE & RELIABLE · AGGRESSIVE & CREATIVE  
DEMANDING FOR PERFECTION · CONSTANT OPERATION

**QUALITY POLICY:** QUALITY STABILITY · CUSTOMER SATISFACTION

經營理念：穩健踏實、精進創新、止於至善、永續經營。

品質政策：品質穩定、客戶肯定。



**山田順精機股份有限公司**  
**SANDSUN PRECISION MACHINERY CO., LTD.**

台灣省彰化縣大村鄉中山路三段57巷7號  
NO. 7, LANE 57, SEC. 3, CHUNG-SHAN RD., DAH-TSUEN,  
CHANG-HWA, TAIWAN.

[Http://www.sandsun.com.tw](http://www.sandsun.com.tw)

E-mail: [sandsun@ms26.hinet.net](mailto:sandsun@ms26.hinet.net)

[sandsun@seed.net.tw](mailto:sandsun@seed.net.tw)

**TEL:886-4-8536688 FAX:886-4-8536699**

**廣東服務處**

東莞市虎門鎮東風管理區東北村新區二路

TEL:0769-85569867 FAX:0769-85569867